

User Manual

TC1

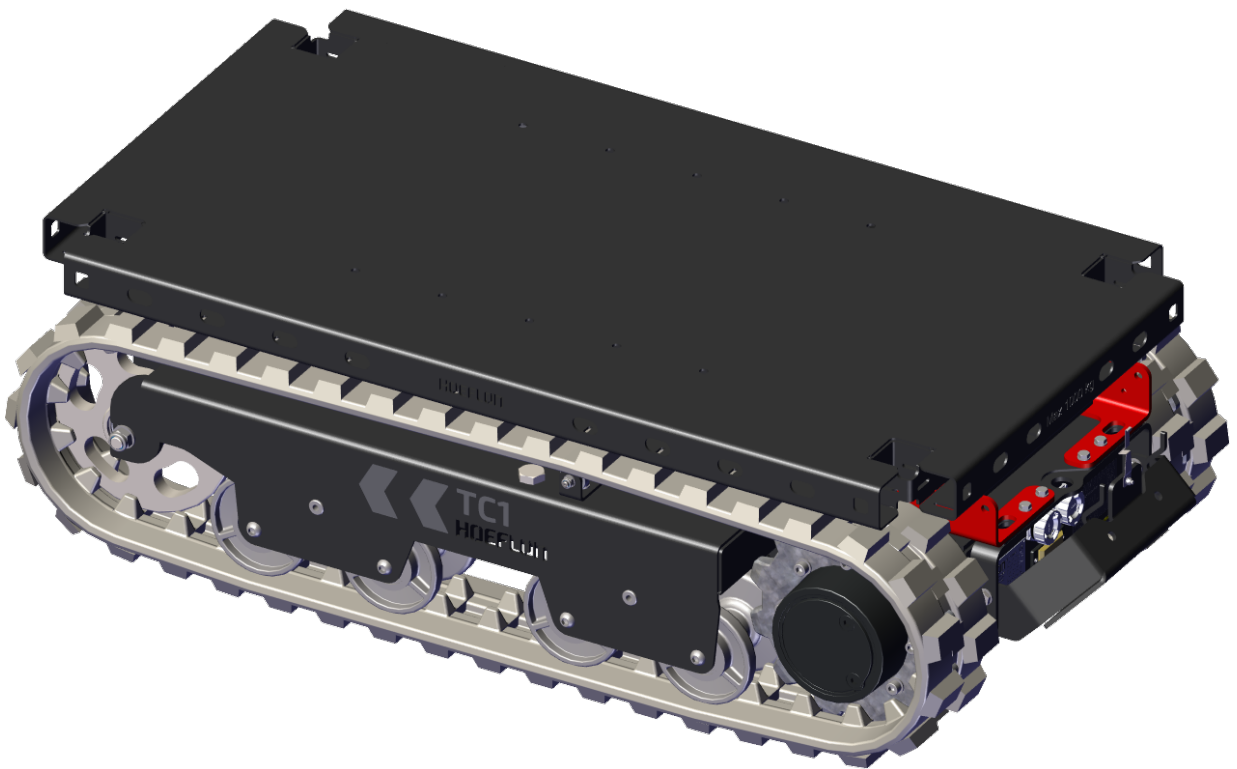

Original instructions

Serial no.:

Delivery date:

Reference: U.TC1.PL.00.EN

Version: 1.0

Table of Contents

Revision control	i
Property rights	i
Preface	ii
General terms & conditions	ii
Warranty and liability	ii
Target audience	iii
Warning icons	iii
Structure of the user manual	iv
1. Introduction	1
1.1 Intended use	1
1.2 Unintended use	1
1.3 EC Declaration	2
1.4 Type plate	2
2. Safety	3
2.1 Introduction	3
2.2 Personnel	3
2.3 Work environment	4
2.4 While working	5
2.5 After work	6
2.6 Pictograms	6
3. Technical data	7
3.1 Dimensions	7
3.2 Center of Gravity	7
3.3 Specifications	7
3.3.1 Basic data	7
3.3.2 Driving conditions	8
3.3.3 Environmental conditions	8
3.3.4 Electrical system	8
4. Description	9
4.1 Main components - Carrier	9
4.2 Main components - Front panel	10
5. Remote control	11
5.1 Introduction	11
5.2 Buttons	12
5.2.1 Control buttons for the tracked carrier	12

5.2.2 Navigation panel	13
5.3 Levers	13
5.3.1 Default configuration	13
5.3.2 "Tank" configuration	14
5.3.3 Calibration	15
5.4 Display	18
5.5 Connect with the tracked carrier	19
5.5.1 The LED does not flash	20
5.5.2 The LED stops flashing and goes OFF	20
5.6 Menu	20
5.6.1 Enter the menu	20
5.6.2 TC1 Data menu	21
5.6.3 Lever calibration	22
5.6.4 Settings menu	22
5.6.5 Select a tracked carrier	24
5.7 Replacing and charging the remote control battery	26
6. Care of the battery pack	27
6.1 Introduction	27
6.2 Charging the battery pack	27
7. Installation	29
7.1 Daily inspection (inspection before use)	29
7.2 Starting and stopping the tracked carrier	30
7.2.1 Starting the tracked carrier	30
7.2.2 Stopping the tracked carrier	30
8. Operation	31
8.1 Moving the tracked carrier	31
8.1.1 Identify the driving mode	31
8.1.2 Using the controls in "Default" mode	32
8.1.3 Using the controls in "Tank" mode	32
8.2 Maximum slope angles when moving an unloaded tracked carrier	32
8.3 Attaching the load	33
8.4 Towing a load	33
9. Maintenance	35
9.1 Introduction	35
9.2 Maintenance work	36
9.2.1 First use	36
9.2.2 Scheduled servicing	36
9.3 Safety during maintenance	36
9.4 Maintenance schedule	38
9.4.1 General	38

9.4.2 Crawler track undercarriage	38
9.4.3 Electrical system	39
9.5 Every 50 hrs	40
9.5.1 Inspect crawler track tension	40
10. Troubleshooting	41
10.1 The remote control cannot connect with the tracked carrier	41
10.1.1 The LED does not flash	41
10.1.2 The LED stops flashing and goes OFF	41
10.2 The tracked carrier will not start	41
10.3 The battery is fully drained	42
10.4 Error codes	42
10.5 Fuses and relays	42
10.5.1 Replace a broken fuse or relay	43
10.5.2 Fuses	44
11. Transport and storage	45
11.1 Transporting a tracked carrier	45
11.1.1 Put the tracked carrier on the transport vehicle	45
11.1.2 Securing the tracked carrier for transport	45
11.2 Lifting the tracked carrier	46
11.3 Putting the tracked carrier in storage	46
11.3.1 Putting the tracked carrier in storage without a charging facility	47
12. Disposal	49
12.1 Dispose of the tracked carrier	49
12.2 Waste disposal	49
Appendix	51
13.1 Maximum slope angles	51
13.1.1 To the side	51
13.1.2 Forward and backward	52

REVISION CONTROL

Revision	Publication date	Comments	From serial number
Version: 1.0	15-09-2025		xxxx xxxx

MANUFACTURER

Hoeflon International B.V.
Zwolleweg 2
3771 NR Barneveld
www.hoeflon.com

General inquiries

T: +31(0) 342 400 288
E: info@hoeflon.com

Technical support

E: support@hoeflon.com

PROPERTY RIGHTS

All rights reserved. No part of this publication may be reproduced, kept in a storage system, or transmitted in any form or by any means (electronically or mechanically, including photocopying, recording or otherwise) without the prior written permission of Hoeflon International B.V. This also applies to the accompanying drawings and charts.

© Copyright 2025

PREFACE

Thank you for buying the Hoeflon TC1. We hope that you enjoy using it and that you will enjoy using it for many years to come.

This user manual contains the operating instructions for the Hoeflon TC1. In this user manual we will refer to it as the tracked carrier.

Read this user manual carefully to familiarize yourself with the correct operation and maintenance of the tracked carrier. The figures in this document are for illustration purposes only and can be different from the tracked carrier in your situation.

Hoeflon International B.V. recommends that you keep the original copy of this user manual, including all the annexes, in a safe, central place. Keep a copy of this user manual near the machine at the workplace.

General terms & conditions

In all cases, Hoeflon International B.V. delivers the machine exclusively according to the General Terms and Conditions applicable at the time of purchase. These General Terms and Conditions can be found on the website www.hoeflon.com.

Although Hoeflon International B.V. has made every reasonable effort to make sure that this user manual is as accurate and helpful as possible, Hoeflon International B.V. does not provide any guarantees with regard to the accuracy or completeness of the information provided herein.

Hoeflon International B.V. is committed to keeping the information in this user manual complete, accurate and up to date. Hoeflon International B.V. accepts no liability for the consequences of errors, except in the case of willful intent or deliberate recklessness on the part of Hoeflon International B.V..

Hoeflon International B.V. continuously develops and improves its products, we reserve the right to make changes to the technical design at any time without prior notice.

For technical support, please speak to your Hoeflon dealer.

Warranty and liability

The Hoeflon TC1 conforms to the applicable basic safety and health requirements of the EU directives. It has been carefully tested for trouble-free use at the factory. If the tracked carrier does have problems stop using the tracked carrier and speak to your Hoeflon dealer immediately.

Use the tracked carrier only for transporting loads as described in this user manual. Do not use the tracked carrier in any other way.

Do not use the tracked carrier if:

- it is damaged,
- there is an error,
- if there is a warning.

Repair the tracked carrier first.

Hoeflon International B.V. is not liable for any damage or injury resulting from:

- not obeying the instructions in this user manual,
- exceeding the factory specifications,
- not obeying the legal requirements.

Do not:

- modify the tracked carrier,
- repair the tracked carrier yourself,
- use unauthorized replacement parts.

Make sure that you maintain the tracked carrier correctly as described in this user manual.

Target audience

This user manual is intended for everyone who works with or on the tracked carrier.



Note

Make sure that you have read and fully understand the contents of the user manual of the tracked carrier.

Make sure that you know how to operate the tracked carrier.

Only use the tracked carrier if you are sufficiently trained and fully know how to use the tracked carrier. Obey your local laws on training and equipment competence. Hoeflon International B.V. can give training on how to use the tracked carrier.

Always stay safe in familiar and unfamiliar situations.

Warning icons

The instructions, recommendations and warnings in this user manual are accompanied by the following terms and pictograms. Read these instructions carefully.



Danger

Identifies a very dangerous situation which, if not prevented, can result in death or very bad injury.



Warning

Identifies a dangerous situation where there is a risk of bad injury.



Caution

Identifies a situation where equipment or property can be damaged; or if there is a risk of injury.



Note

Identifies important information to help you understand or adjust the equipment.

Structure of the user manual

Preface describes the purpose of the manual, general terms and conditions, warranty and liability, target audience and notes for the reader.

Introduction includes an introduction to the tracked carrier.

Safety lists all the points the user needs to know to work safely with the tracked carrier.

Technical data gives the dimensions and specifications of the tracked carrier.

Description describes the main components of the tracked carrier and the operation of its various components.

Installation gives information on attaching each component.

Operation gives operating instructions for the intended use of the tracked carrier.

Maintenance gives information on the necessary maintenance.

Troubleshooting lists possible faults and how to solve them.

Transport and storage gives recommendations for transporting and putting the tracked carrier in storage.

Disposal gives instructions for the disposal of the tracked carrier.

1.

Introduction

1.1 Intended use

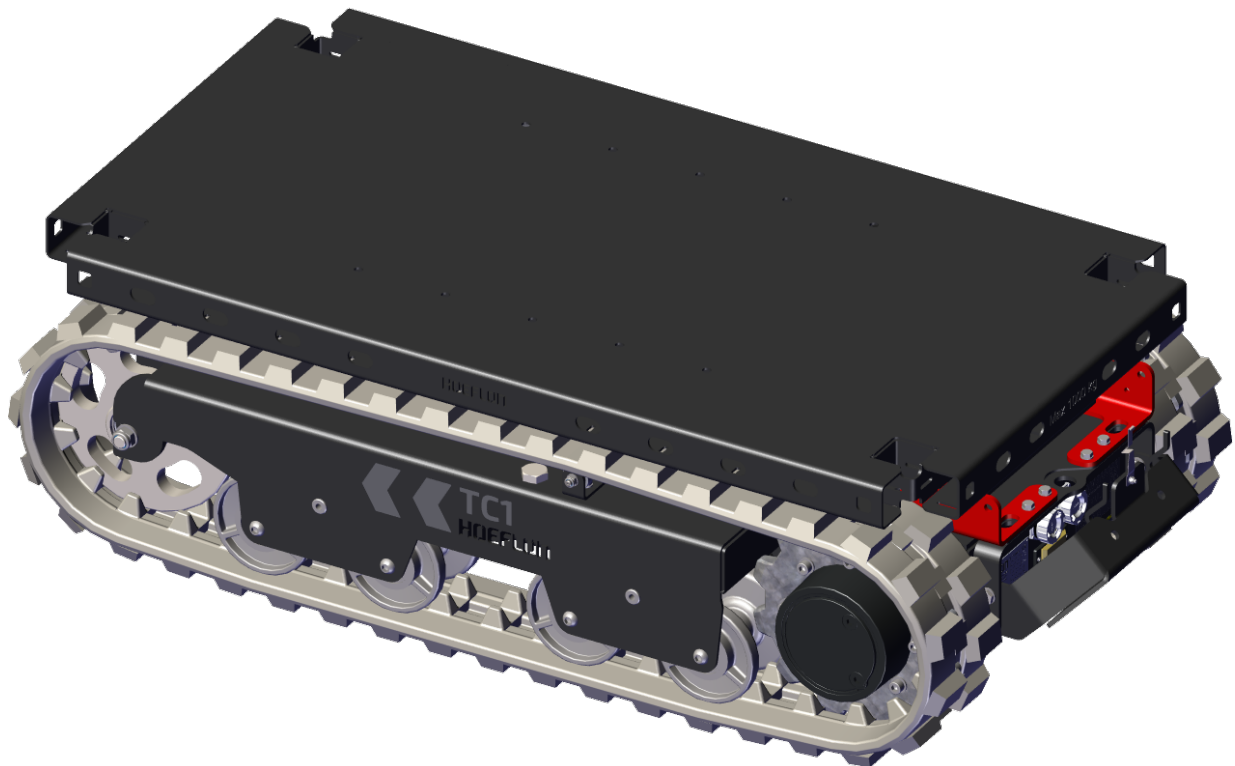

Only use the tracked carrier to transport goods (see 3.3.1 Basic data) for more information.
The tracked carrier can be used indoors and outdoors (see 3.3.3 Environmental conditions).
Use the remote control to control the tracked carrier.

1.2 Unintended use

Do not use the tracked carrier for prying or pushing.

1.3 EC Declaration

Hoefflon International B.V. declares that the tracked carrier conforms with the applicable European Directives. The EC Declaration of Conformity is part of the documentation which is supplied with the tracked carrier.

1.4 Type plate

A type plate containing the machine data is attached to the rear of the tracked carrier behind the cover. Do not remove the type plate. The CE mark indicates that the tracked carrier conforms to the applicable standards for the European Economic Area.

HOEFLON ®		CE 2006/42 CE	
Zwolleweg 2	tel: +31(0)342 400288		
3771 NR Barneveld	info@hoefflon.com		
THE NETHERLANDS	www.hoefflon.com		
Type	<input type="text"/>	Year of Registration	<input type="text"/>
Model	<input type="text"/>		
Serial No.	<input type="text"/>	Year of Manufacture	<input type="text"/>
Weight	<input type="text"/> KG	Max. Capacity	<input type="text"/> KG

Type	The type of machine
Model	The brand of the machine
Serial no.	The serial number of the machine
Year	The year the machine was built
Weight	The weight of the machine
Max. capacity	Maximum working load



Note

Please provide the type number and serial number when ordering parts.

2.

Safety

2.1 Introduction

Make sure that you have read the manual of the tracked carrier and that you fully understand its contents.

Make sure that you understand and obey all applicable legal requirements on using the tracked carrier before you start work.

When using the tracked carrier:

- Obey all warnings and regulations.
- Obey all applicable national regulations about:
 - working with the tracked carrier,
 - working conditions,
 - work safety.

Obey the general safety precautions in this chapter when using the tracked carrier.

Always be aware of the weight of the components and the loads.

Only use the correct tools.

Keep the tracked carrier clean.

2.2 Personnel

**Note**

Make sure that all personnel that works with the tracked carrier has the necessary licenses and work permits as specified by your local laws on training and equipment competence.

**Caution**

Always use approved Personal Protective Equipment (PPE).

- Hardhat
- Safety shoes
- Gloves
- Safety glasses

All operating personnel must:

- be fit to do the task.
- stay out of the operating radius of the tracked carrier.
- fully know the content of the user manual of the tracked carrier.
- be familiar with all the functions and attachments associated with the equipment.
- be at least 18 years of age.

Do not:

- be under the influence of narcotics or alcohol.

2.3 Work environment

Make sure that the environmental and operational conditions are safe and within limits before using the tracked carrier.

Make sure that the ground is stable and has sufficient load bearing capacity.

Make sure that the ground is not slippery.

Put barriers and safety warnings around the perimeter of the work area. Do not let unauthorized people in the work area.

Use extra light in dark areas.

Do not smoke or make fire in the work area.

Use communication equipment and a spotter if you cannot fully view the entire work area.

Obey the height restriction in covered areas.

Do not use the tracked carrier:

- if it is not safe,
- near high voltage cables,
- in an explosive environment.

2.4 While working

**Caution**

If you use the tracked carrier incorrectly, incorrect and high forces can permanently damage or shorten the life of the tracked carrier.

**Caution**

Make sure that the platform is dry and not slippery before putting a load on the tracked carrier.

**Warning**

Stop work and move the tracked carrier into a safe position if a safety feature stops working or becomes damaged.

**Caution**

Do not let anybody on the tracked carrier.

Fully prepare the task.

Continuously monitor the work area.

Do not let unauthorized people in the work area.

Prevent dangerous situations between:

- the tracked carrier,
- the operator,
- other people,
- the load,
- the surroundings,
- the ground.

Do not:





- enter the work area during operation of the tracked carrier,
- let anybody enter the work area during operation of the tracked carrier,
- touch rotating parts,
- touch moving parts.

2.5 After work

- Remove the key before that you leave the tracked carrier unattended.
- Remove all safety barriers and warning signs.

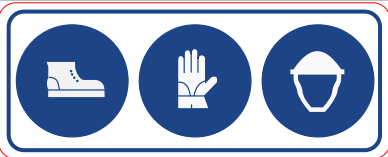
2.6 Pictograms

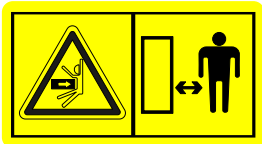
The pictograms used are shown below. Do not remove these pictograms. Replace missing or damaged pictograms immediately.

Pictogram	Meaning	Location
	<ul style="list-style-type: none"> • Foot protection is mandatory • Hand protection is mandatory • Head protection is mandatory 	On the frame at the rear of the tracked carrier.
	Read the user manual first.	On the frame at the rear of the tracked carrier.
	<p>Danger of crushing when operating the tracked carrier.</p> <p>Stay away from the tracked carrier.</p>	On the frame at the rear of the tracked carrier.
	Warning for non-ionising radiation	On the frame at the front of the tracked carrier.
	Label that shows when annual inspection is due (Netherlands only)	On the frame at the rear of the tracked carrier.

3.

Technical data

3.1 Dimensions

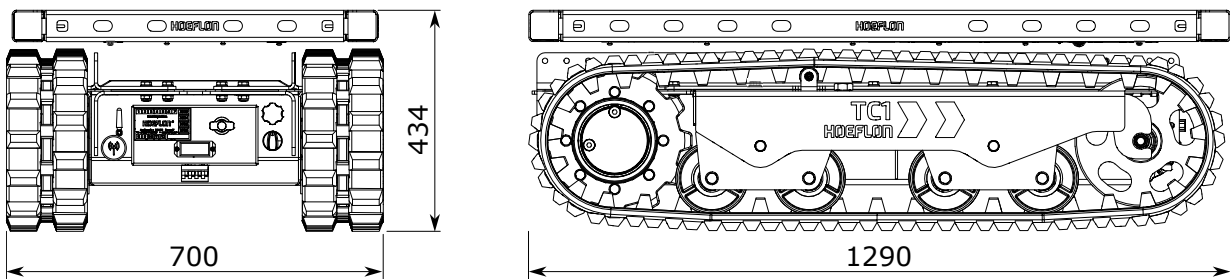

3.2 Center of Gravity

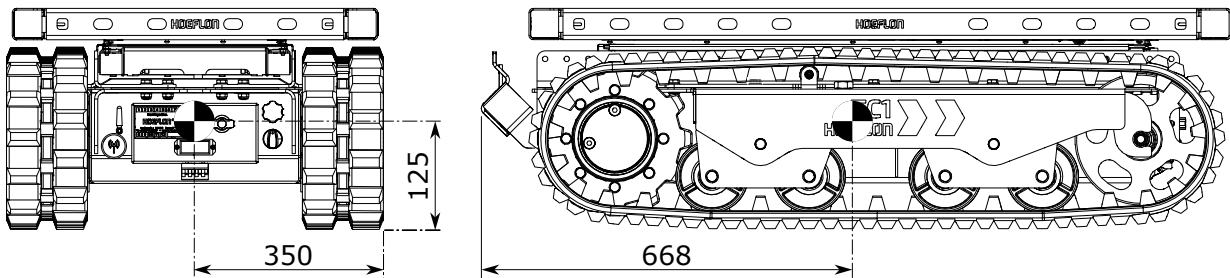

3.3 Specifications

3.3.1 Basic data

Machine brand	Hoeflon
Mass of non-loaded machine	360 kg
Maximum load-bearing capacity	1000 kg

3.3.2 Driving conditions

Driving speed	6 km/h
Ground clearance	85 mm
Clearance angle	80° Front and rear
Maximum slope angle	(see 13.1 Maximum slope angles) in the appendix.
Maximum lean angle	(see 13.1 Maximum slope angles) in the appendix.
Minimum ground pressure - Unloaded	1229 kg/m ²
Maximum ground pressure - Fully loaded	4641 kg/m ²

3.3.3 Environmental conditions



Caution

The load and/or carrier can topple if there is a strong wind and a high load.

Ambient temperature	-10 to 40 °C
Maximum wind speed	No wind restrictions

3.3.4 Electrical system

Capacity	3 kW
Battery pack	48 V
Battery charging time	4 hr
Battery charging voltage	230 V

4.

Description

4.1 Main components - Carrier

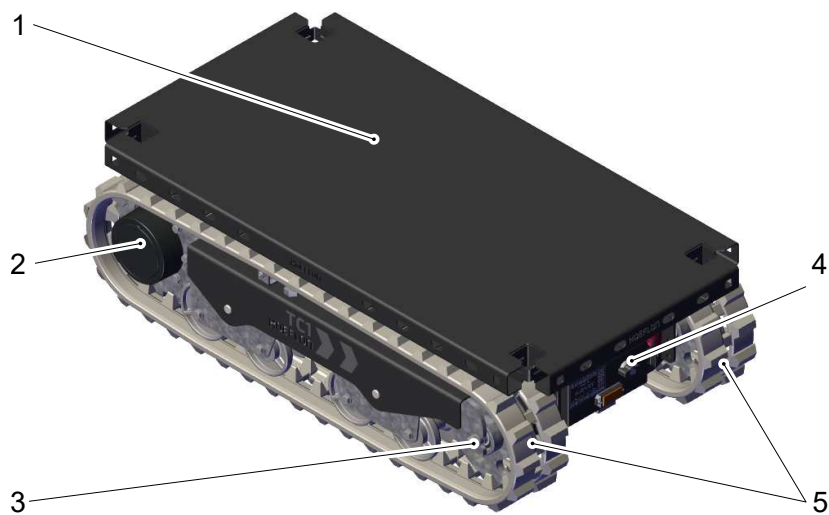

1. Platform
2. Drive wheel
3. Tension wheel

4. Front panel
5. Track

4.2 Main components - Front panel



- | | |
|--|------------------------|
| 1. Battery remote control - Charging panel | 6. Emergency stop |
| 2. Antenna | 7. Start / stop switch |
| 3. Fuse box - 12V | 8. Charging cable |
| 4. Second battery for the remote control | 9. Panel cover (open) |
| 5. Fuse box - 48V | |

5.

Remote control

5.1 Introduction



Use the remote control to operate the TC1.

Wear the remote control using the belt or the shoulder strap.

Always have a second battery in the charger.

- Keep the remote control clean.
- Make sure that you can read the pictograms and the display.



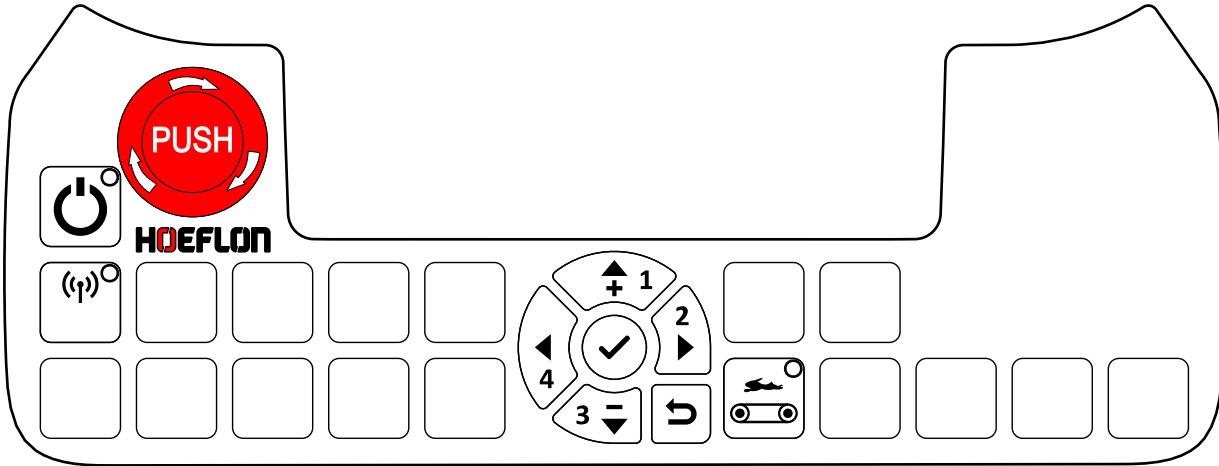

The remote control is sealed against splashed water and rain.

- Do not clean the remote control or the receiver with high pressure.
- Do not soak the remote control or the receiver in liquid.

5.2 Buttons

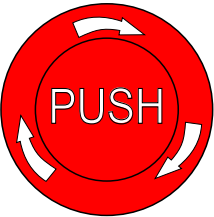

5.2.1 Control buttons for the tracked carrier

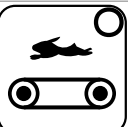
Button	Function	Explanation
	Emergency stop	Immediately stops all functions of the tracked carrier. <div style="display: flex; align-items: center;">  <p>Caution ONLY use in an emergency. Do not use this button for ANY other reason.</p> </div>
	On/Off	Start and stop the remote control. The remote control is ON when the LED is ON.
	Connect remote control and tracked carrier	Push once to connect the remote control with the tracked carrier. The remote control is connected to a tracked carrier when the LED is ON
	Driving speed	The default speed of the tracked carrier is the speed that is set in the settings menu (see 5.6.4 Settings menu). Toggle between the default speed and FULL speed (100%). The tracked carrier operates at FULL speed when the LED is ON.



Note

If a LED is lit, the function is active.

5.2.2 Navigation panel

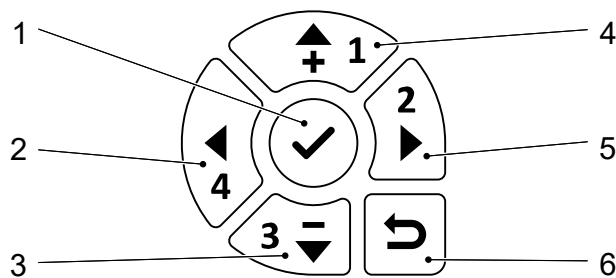

- | | |
|---------------------------|----------------------------|
| 1. Confirm / go into menu | 4. Up |
| 2. Left | 5. Right |
| 3. Down | 6. Return to previous menu |

Use the navigation panel on the remote control:

- to navigate through the menus.
- to view the TC1 Data menu (see 5.6.2 TC1 Data menu).
- to calibrate the levers (see 5.3.3 Calibration)
- to change the settings of the tracked carrier (see 5.6.4 Settings menu).
- to select a different tracked carrier (see 5.6.5 Select a tracked carrier).

5.3 Levers

5.3.1 Default configuration

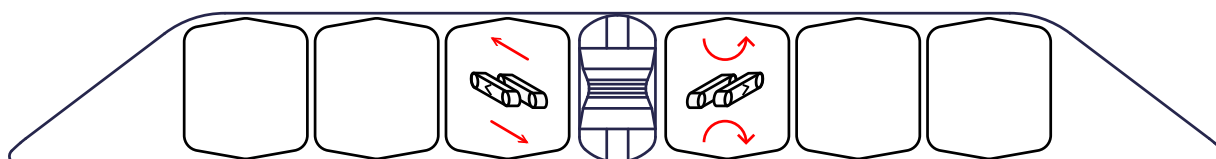

Image	Function	Pull the lever rearward	Push the lever forward
	Move the tracked carrier forward and rearward	The tracked carrier goes rearward	The tracked carrier goes forward
	Turn the tracked carrier	The tracked carrier turns clockwise	The tracked carrier turns counterclockwise

5.3.2 "Tank" configuration

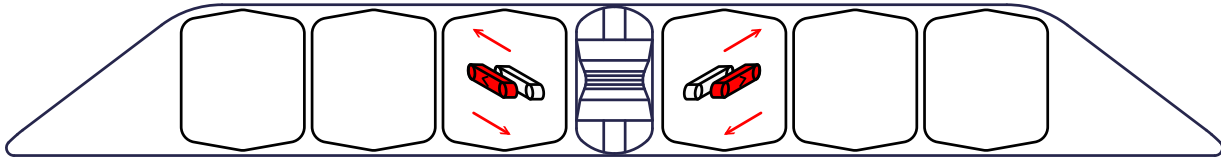

Image	Function	Pull the lever rearward	Push the lever forward
	Operate crawler track (L – left)	Backwards	Forwards
	Operate crawler track (R – right)	Backwards	Forwards

5.3.3 Calibration

Inspect the lever calibration

Calibrate the levers if:

- the levers of the remote control do not respond over the entire range of movement.
- the remote control cannot connect to the tracked carrier.



Note

If the levers are in the central position but the remote control gives a "out of center" response then the remote control cannot connect to the tracked carrier.

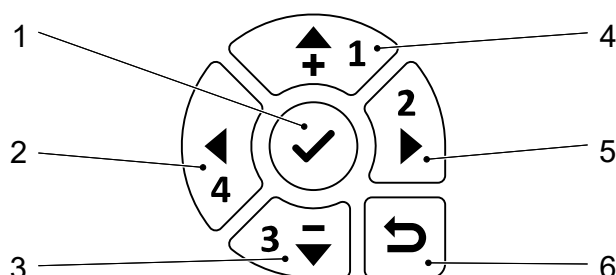

- | | |
|---------------------------|----------------------------|
| 1. Confirm / go into menu | 4. Up |
| 2. Left | 5. Right |
| 3. Down | 6. Return to previous menu |

1. Start the remote control.
2. Push the **Confirm** button (1) to go into the *remote control menu*.
3. Push the **Down arrow** to move the arrow in the display until it points to *Lever calibration*.



4. Push the **Confirm** button (1) to go into the *Lever calibration* menu.

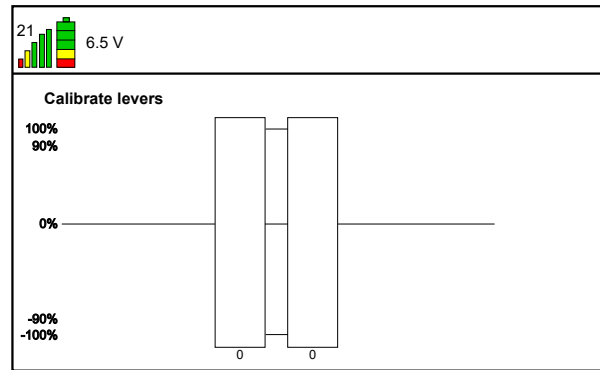

5. When you operate a lever the related bar must turn green.
6. Fully push the lever.
- The green bar must be at 134.
 - Recalibrate the lever if the green bar is at 134 before fully pushing the lever.
 - Recalibrate the lever if the green bar is not at 134.

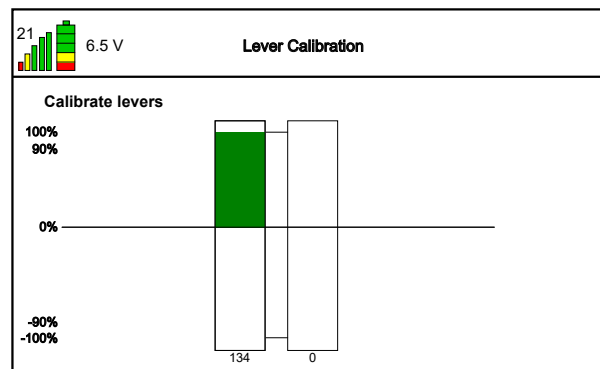

7. Fully pull the lever.
- The green bar must be at -134.
 - Recalibrate the lever if the green bar is at -134 before fully pulling the lever.
 - Recalibrate the lever if the green bar is not at -134.
8. Do steps 6 and 7 again for the remaining levers.

Calibrate the levers:

1. Push the **Confirm** button (1). The text *Put levers in center* is now displayed.
2. Make sure that all the levers are in the center position.

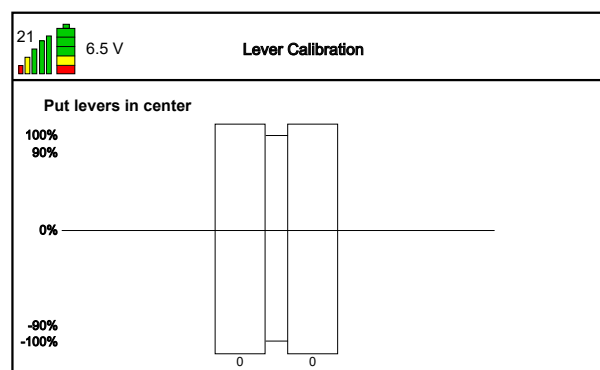

3. Push the **Confirm** button (1). The text *Move levers back and forth* is now displayed.
4. Slowly move the levers one at a time, from all the way back to all the way forward.



5. Push the **Confirm** button (1). The text *Save calibration* is now displayed.
6. Move the levers one after the other. Move the levers all the way in both directions.
7. Make sure that each bar becomes fully green.
8. Push the **Confirm** button (1). The settings are saved
9. Push the **Back** button (6) two times to go back to the home screen.



Incorrect calibration

This screen is shown if a lever does not operate correctly.

Do not use the tracked carrier.

Speak to your your Hoeflon dealer.

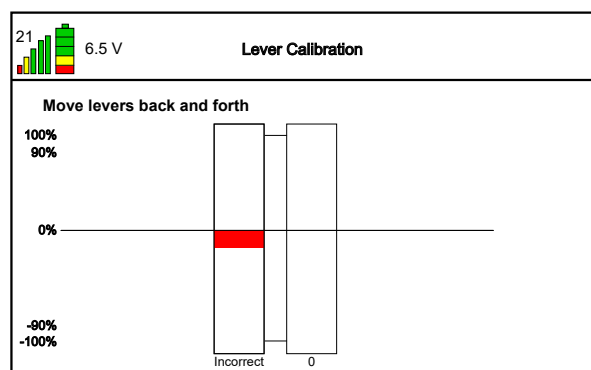

5.4 Display

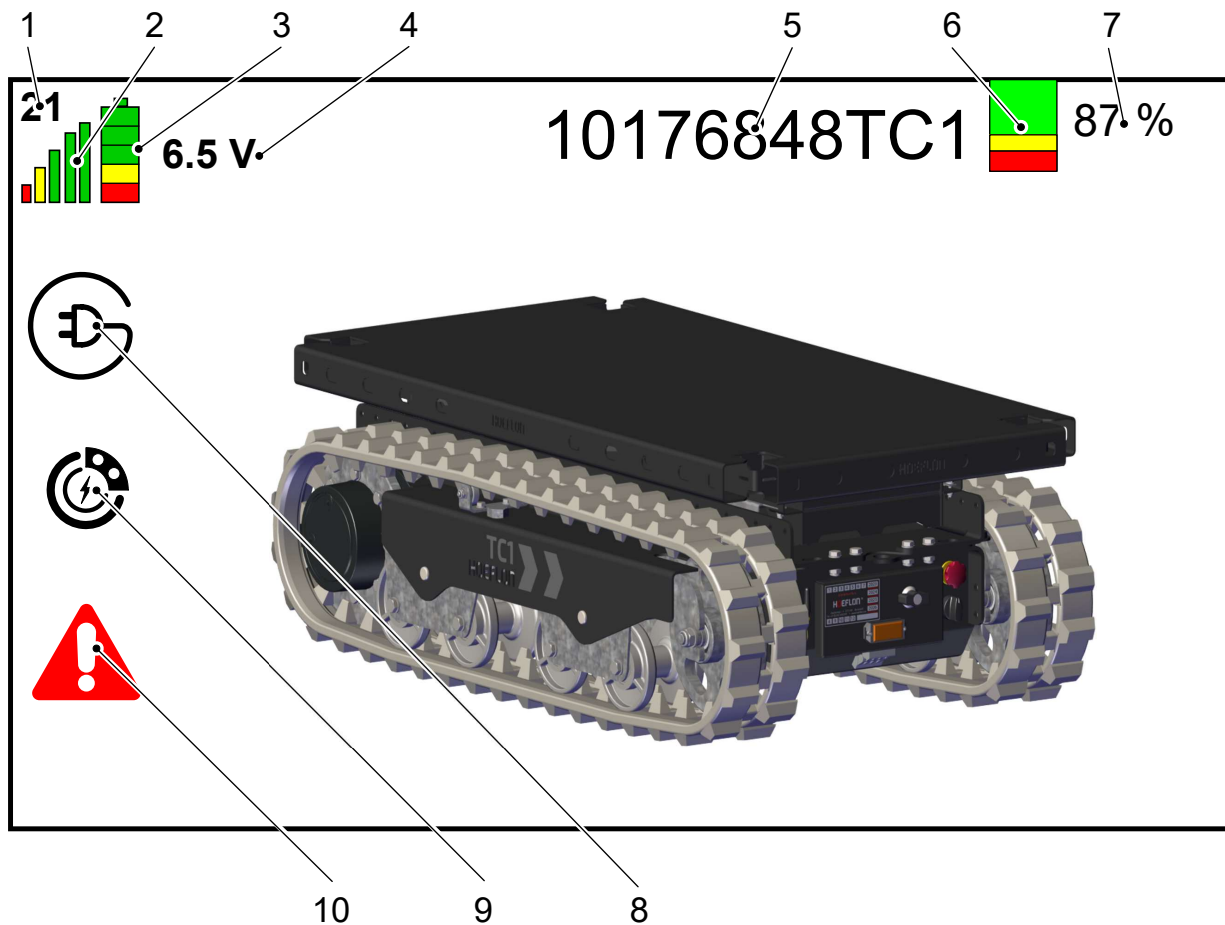

No.	Function	Explanation
1	Channel	The communication channel that is used. This may change when you start the remote control again.
2	Signal strength	More bars > Better signal Stop and start the remote control to select a different channel if the signal is too weak.
3	State of charge of remote control battery	More bars > More charge. Replace the battery when only the red bar shows (see 5.7 Replacing and charging the remote control battery)
4	Voltage	The battery voltage of the remote control.
5	Carrier identification	Tells the operator to which tracked carrier the remote control is connected
6	State of charge of tracked carrier battery	Green > Sufficient charge Yellow > Charging necessary Red > Charge is not sufficient. Charge immediately

No.	Function	Explanation
7	State of charge of tracked carrier battery [%]	The remaining charge in the battery
8	Charging indicator	The symbol is only visible when the carrier is charging. The symbol is not visible with normal use.
9	Regenerating indicator	The symbol is only visible when the carrier is regenerating (for example: when it is going downhill). The symbol is not visible with normal use.
10	Error indicator	The symbol is only visible when the carrier has an error (see 10.4 Error codes). The symbol is not visible with normal use.

5.5 Connect with the tracked carrier

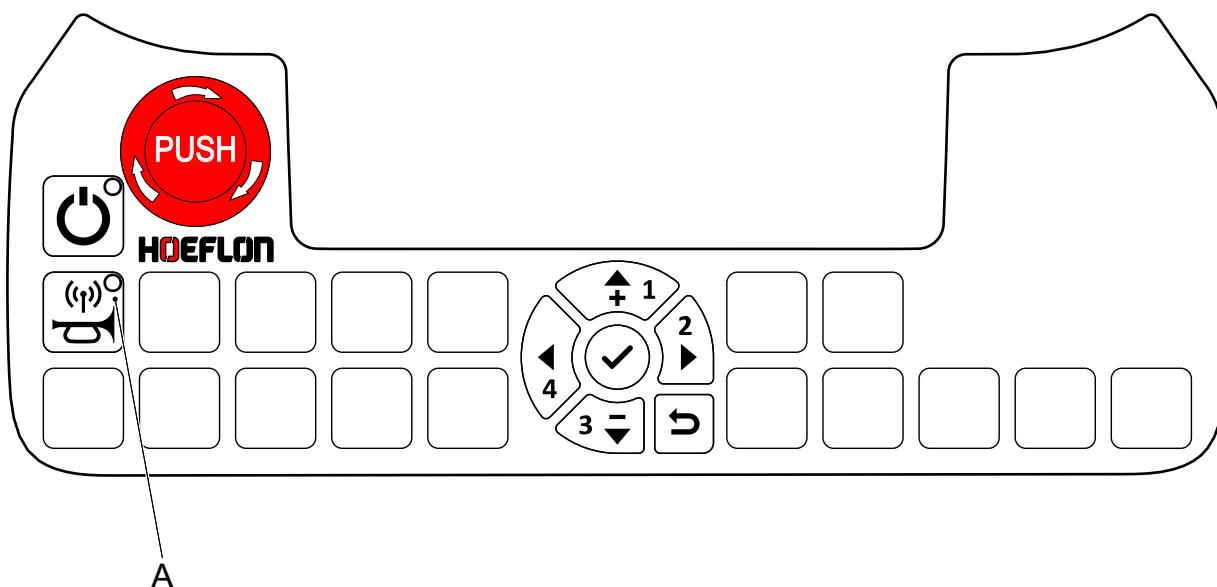

1. Start the tracked carrier and the remote control.
2. Make sure that the LED on button A is OFF.



Note

The remote control is already connected to a tracked carrier if the LED is ON.

3. Push the **Connect** button (A).
4. Look if the LED on the button flashes.
 - If the LED flashes the RC6 is trying to connect to the tracked carrier.
 - If the LED does not flash, then there is a problem with the RC6.
 - When the light is ON, the RC6 is connected to the tracked carrier.
 - If the LED goes OFF, the RC6 cannot connect.

5.5.1 The LED does not flash

There is a problem with the RC6.

1. Make sure that all the levers are in the central position.
2. Calibrate the RC6 if all the levers are in the central position (see 5.3.3 Calibration)
3. Do an inspection of the **Connect** button (A).
4. Speak to your Hoeflon dealer if you still cannot connect.

5.5.2 The LED stops flashing and goes OFF

There is a problem with the tracked carrier. Speak to your Hoeflon dealer. Do not continue working.

5.6 Menu

The default settings are set by Hoeflon. You can change some of the settings if necessary.

5.6.1 Enter the menu

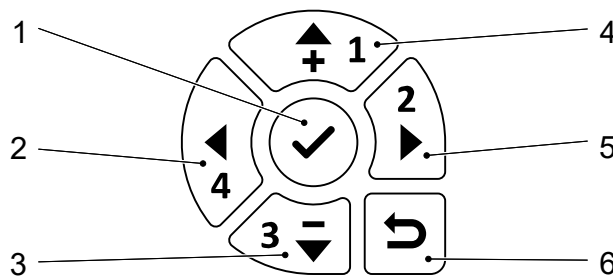

- | | |
|---------------------------|----------------------------|
| 1. Confirm / go into menu | 4. Up |
| 2. Left | 5. Right |
| 3. Down | 6. Return to previous menu |

1. Start the remote control.
2. Push the **Confirm** button (1) to go into the *Menu*.

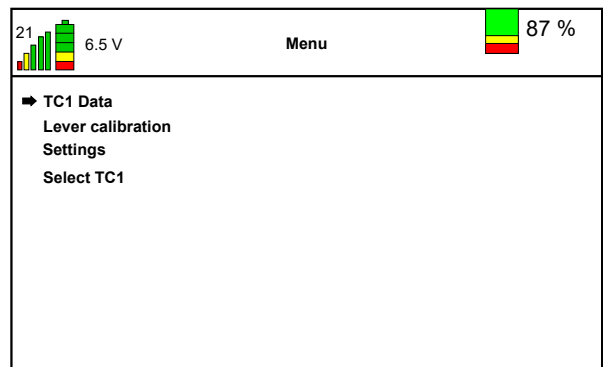

	Description
TC1 Data	Displays additional information for maintenance or troubleshooting purposes.
Lever calibration	Calibrate levers, (see 5.3.3 Calibration).
Settings	Inspect and change advanced settings of the TC1, (see 5.6.4 Settings menu).
Select TC1	Use this menu to connect to a different tracked carrier, (see 5.6.5 Select a tracked carrier).

5.6.2 TC1 Data menu

Enter the Data menu

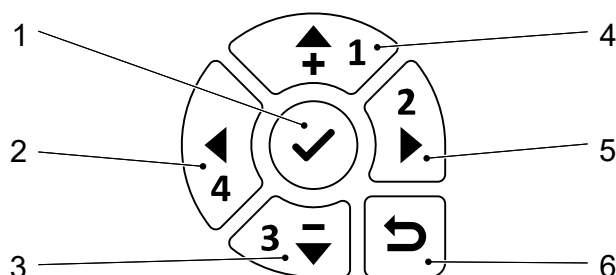

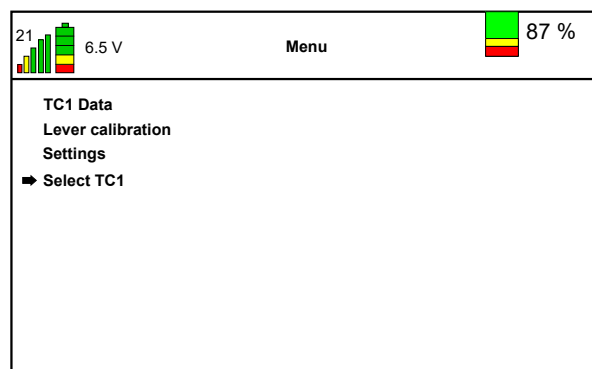

- | | |
|---------------------------|----------------------------|
| 1. Confirm / go into menu | 4. Up |
| 2. Left | 5. Right |
| 3. Down | 6. Return to previous menu |

1. Start the remote control.
2. Push the **Confirm** button (1) to go into the *Menu*.
3. Make sure that the arrow in the display points to *TC1 Data*.
 - Push the **Up arrow** or the **Down arrow** to move the arrow in the display until it points to *TC1 Data*.
4. Push the **Confirm** button (1) to go into the *TC1 Data menu*.

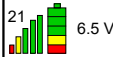

This is a display menu only. There are no settings that you can change.

21		6.5 V	TC1 Data	 87 %
SoC	:	47 %		
Motor Contr. temperature	:	24 °C		
Motor 1 temperature	:	24 °C		
Motor 2 temperature	:	24 °C		
	:			
Hourcounter	:	00022:14		
Hourcounter drive	:	00000:25		
Error code Motor Contr.	:	no error		
Error code accupack	:	no error		

Data type	Description
SoC	The "State of Charge" of the battery.
Motor Contr. temperature	Displays the temperature of the motor controller in C°.
Motor 1 temperature	Displays the temperature of motor 1 (the left motor) in C°.
Motor 2 temperature	Displays the temperature of motor 2 (the right motor) in C°.
Hour counter	Displays the number of hours that the tracked carrier has been ON.
Hour counter - drive	Displays the number of hours that the tracked carrier has actually driven.
Error code Motor Contr.	Displays the error in the motor controller (if applicable), (see 10.4 Error codes).
Error code accupack	Displays the error in the battery pack (if applicable), (see 10.4 Error codes).

5.6.3 Lever calibration

Select this menu to calibrate the levers on your remote control, (see 5.3.3 Calibration).

5.6.4 Settings menu

The default settings are set by Hoeflon. You can change some of the settings if necessary.

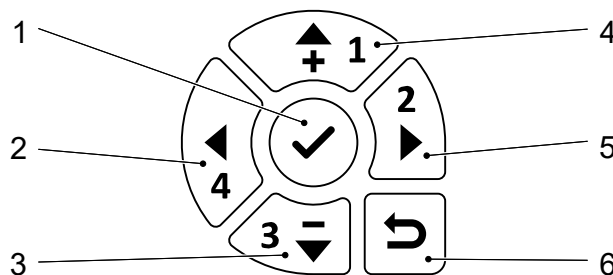

Enter the settings menu

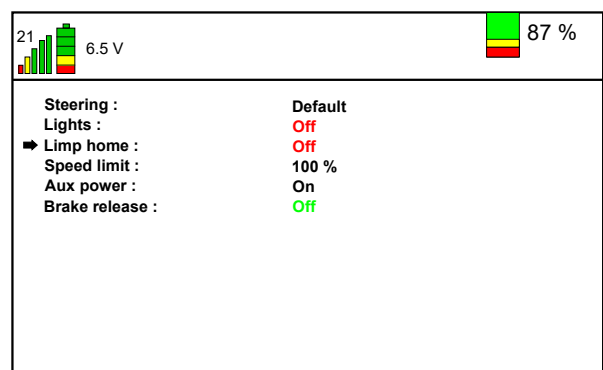
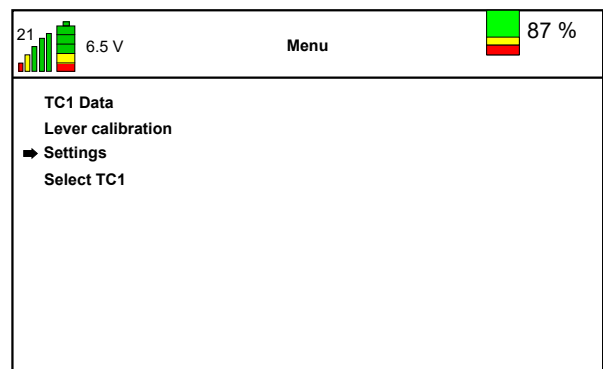

- | | |
|---------------------------|----------------------------|
| 1. Confirm / go into menu | 4. Up |
| 2. Left | 5. Right |
| 3. Down | 6. Return to previous menu |

1. Start the remote control.
2. Push the **Confirm** button (1) to go into the *Menu*.
3. Make sure that the arrow in the display points to *Settings*.
 - Push the **Up arrow** or the **Down arrow** to move the arrow in the display until it points to *Settings*.
4. Push the **Confirm** button (1) to go into the *Settings menu*.
5. Select the setting that you want to change.



Setting	Description						
Steering	Toggle between "Default" and "Tank" steering mode (see 8.1 Moving the tracked carrier).						
Lights	<p>Toggle the work lamps "ON", "OFF" or "AUTO" on the tracked carrier.</p> <p> Note</p> <p>In the "AUTO" position the lamps are OFF when the tracked carrier is stopped. The lights are on when driving.</p>						
Limp home	<p>Set "Limp home" ON so that you can move the tracked carrier to a safe place or a charging station if the batteries are nearly empty.</p> <p> Warning</p> <p>Do not go into "Limp home" for any other reason. Do not do any work in "Limp home". You will break the batteries.</p>						
Speed limit	Lower the speed limit so that you have more accurate control of the tracked carrier.						
Aux power	<p>The auxiliary power supplies electrical power to the scissor lift.</p> <table border="1"> <tbody> <tr> <td>ON</td> <td>The Auxiliary power is always ON.</td> </tr> <tr> <td>AUTO</td> <td>The Auxiliary power is ON when necessary.</td> </tr> <tr> <td>OFF</td> <td>The Auxiliary power is OFF.</td> </tr> </tbody> </table>	ON	The Auxiliary power is always ON.	AUTO	The Auxiliary power is ON when necessary.	OFF	The Auxiliary power is OFF.
ON	The Auxiliary power is always ON.						
AUTO	The Auxiliary power is ON when necessary.						
OFF	The Auxiliary power is OFF.						
Brake release	<p>Release the breaks if the tracked carrier is stranded and must be towed to safety.</p> <p> Caution</p> <p>Do not go faster than 15 km/h when you tow the tracked carrier with released brakes.</p>						

5.6.5 Select a tracked carrier

You can select any tracked carrier within range of the RC6.



Note

You must disconnect from the current tracked carrier first.

Make sure that the tracked carrier that you want to connect to is ON.

Enter the Select TC1 menu

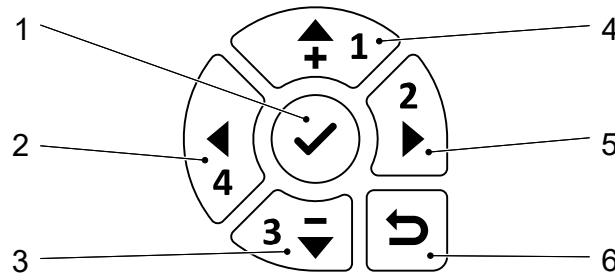

- | | |
|---------------------------|----------------------------|
| 1. Confirm / go into menu | 4. Up |
| 2. Left | 5. Right |
| 3. Down | 6. Return to previous menu |

1. Start the remote control.
2. Push the **Confirm** button (1) to go into the *Menu*.

3. Make sure that the arrow in the display points to *Select TC1*.
 - Push the **Up arrow** or the **Down arrow** to move the arrow in the display until it points to *Select TC1*.

4. Push the **Confirm** button (1) to go into the *Select TC1 menu*.

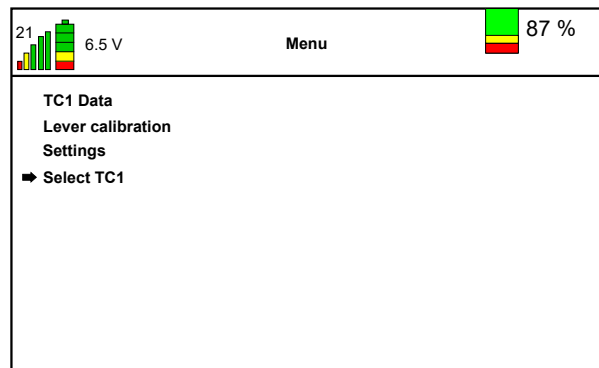

5. Select the tracked carrier that you want to connect to.
 - Push the **Up arrow** or the **Down arrow** to move the arrow in the display until it points to the tracked carrier that you want to connect to.

6. Push the **Confirm** button (1) to connect to the tracked carrier.

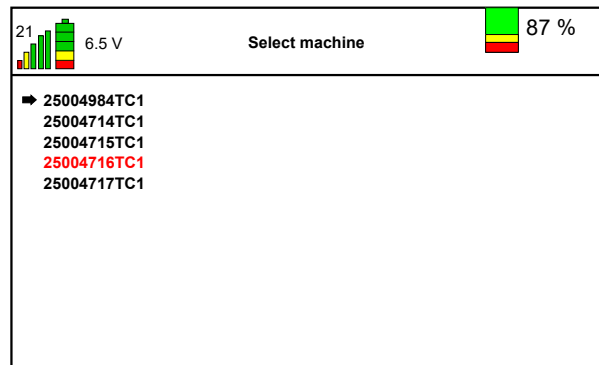

7. Push the **Return to previous menu** button to return to the *Menu*.

 **Note**

The tracked carrier that is marked in **Red** is the last selected tracked carrier.

5.7 Replacing and charging the remote control battery

1. Push in the two clips (1) on the remote control next to the battery (2).
2. Remove the discharged battery (2) from the remote control.
3. Push the charged battery in position.
 - The two clips lock in position, listen for both "clicks".



4. Turn the handle and open the cover on the front of the tracked carrier.
5. Put the discharged battery in the battery charger.
 - The battery only charges if the main switch is in position 1.
6. Start the remote control and make contact with the tracked carrier again.

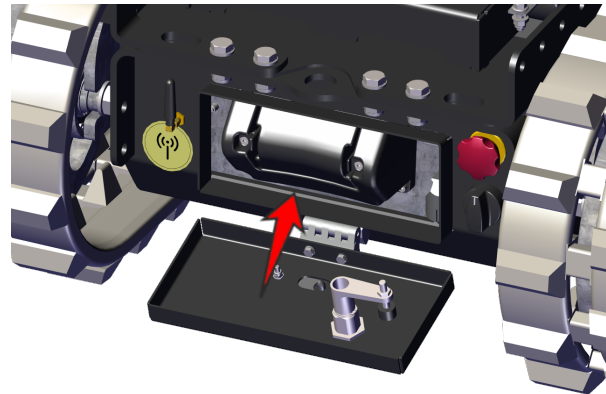

The display on the battery charger gives information about the battery charger and the battery.

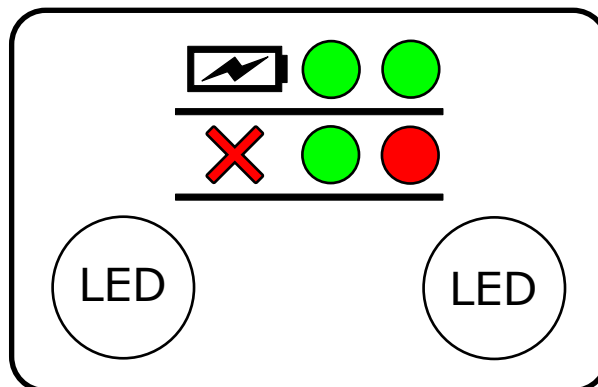

Left LED		Right LED	
Charger status & faults		Battery status	
Short green flash every 2 seconds	Power supply connected	Off	Battery not connected
Continuous red	Fault	Continuous green	Battery fully charged
		Flashing green	Charging
		Continuous red	Fault in the battery

6.

Care of the battery pack

6.1 Introduction

Do not open or disassemble the battery pack or the charger.

Charge the battery pack at the end of each day. This keeps it balanced and in a good condition.

Make sure that the emergency stop button is OUT.



Caution

Do not use the emergency stop button to stop the tracked carrier during normal operation.

ONLY use the emergency stop button in an emergency.

Reset the emergency stop button as soon as it is safe to do so.

If the tracked carrier's key switch is OFF, the battery pack will charge normally.

If the tracked carrier's key switch is ON:

- Most of the charge goes to operating the tracked carrier.
- The battery pack will continue to charge.
- Lower charging efficiency.
- Longer charging time.

Fully charge the battery once a week. This maximizes the battery's performance.

6.2 Charging the battery pack



Caution

Do not charge the tracked carrier in the rain. The electrical components have no protection from the rain when the cover is open.



Note

The charging properties of the battery pack change at different temperatures.

1. Stop the tracked carrier.
2. Use the charging cable at the front of the tracked carrier.
 - Turn the handle and open the cover on the front of the tracked carrier.
 - Fully unwind the cable before charging.
3. Make sure that the charging cable plugs are clean and dry.
4. Connect the plug to the power grid.
 - Charging starts automatically.
5. Start the remote control and look at the a start screen.
 - The state of charge is shown in the top right corner, (see 5.4 Display).
6. When the tracked carrier is charged:
 - a. Disconnect the charging cable from the power grid.
 - b. Fully wind the charging cable back in its storage in the TC1.

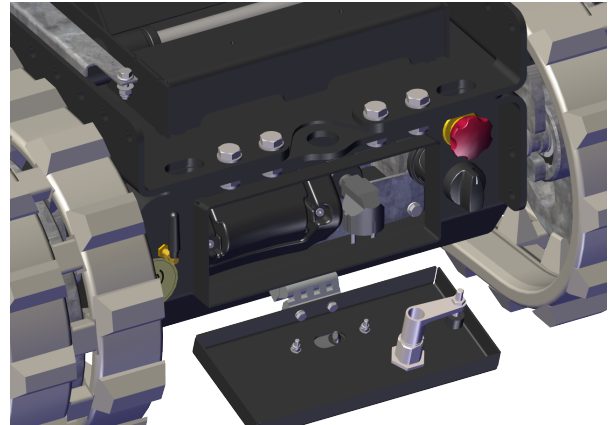

7.

Installation

7.1 Daily inspection (inspection before use)

1. Make sure that the tracked carrier is OFF.
2. Remove the key.
3. Do a visual inspection of the tracked carrier. Make sure that:
 - there are no loose connections,
 - there is no damage,
 - all nuts and bolts are in position and tight,
 - all loose parts are correctly secured.
4. Do a visual inspection of the tension and condition of the crawler tracks .
 - Speak to your Hoeflon dealer if a track is too tight or too loose. Do not continue working.
 - Speak to your Hoeflon dealer if a track is damaged. Do not continue working.
5. Make sure that:
 - the control levers return to the center position automatically,
 - the emergency stop button operates correctly,
 - all rotating and moving parts are not worn or damaged.
6. Speak to your Hoeflon dealer if you find any:
 - damage,
 - leaks,
 - worn parts,
 - broken parts.
7. Start the tracked carrier (see 7.2.1 Starting the tracked carrier).

7.2 Starting and stopping the tracked carrier

7.2.1 Starting the tracked carrier

1. Make sure that:
 - all emergency stop buttons are pulled out.
 - the charging cable is wound in its storage.
 - all levers of the remote control are in the center position. If one or more levers are not in the center position, the remote control cannot connect to the tracked carrier.
2. Use the keyswitch to start the tracked carrier.
3. Start the remote control with the **On/off** button.

4. Connect the remote control to the tracked carrier with the **Connect remote control and tracked carrier** button.



Note

The lamps on a tracked carrier flash several times when you have connected a remote control to it.

7.2.2 Stopping the tracked carrier



Caution

Do not use the emergency stop button to stop the tracked carrier during normal operation.

ONLY use the emergency stop button in an emergency.

Reset the emergency stop button as soon as it is safe to do so.

1. Make sure that the tracked carrier is in a safe and stable position.
2. Stop the remote control.
 - Use the On/Off button on the remote control.
3. Stop the tracked carrier.
 - Turn the key switch to position **0**.



Note

If you disconnect the remote control without stopping the tracked carrier the lights on the tracked carrier will flash once every five seconds.

4. Connect the tracked carrier to the mains supply if it is necessary to charge the batteries.

8.

Operation



Caution

Before you move a load with the tracked carrier:

- Make sure that the load is correctly attached to the platform, (see 8.3 Attaching the load).
- Make sure that the load cannot move on the platform.

8.1 Moving the tracked carrier

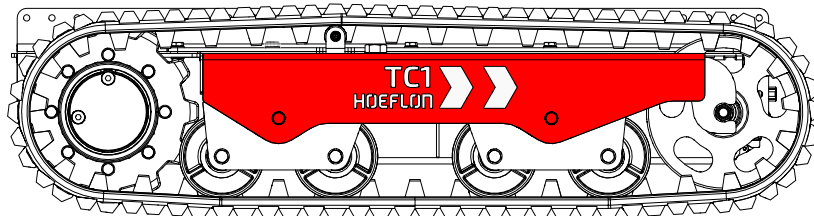

Note

The white arrows show the driving direction.

1. Start the tracked carrier (see 7.2.1 Starting the tracked carrier).
2. Connect the remote control (see 5.5 Connect with the tracked carrier)

8.1.1 Identify the driving mode



Note

Make sure that the tracked carrier can safely move in the direction that you are steering it..

Move the left handle a small distance.

- If the tracked carrier goes straight forward or backward - You are in DEFAULT mode
- If the tracked carrier turns - You are in TANK mode

8.1.2 Using the controls in "Default" mode

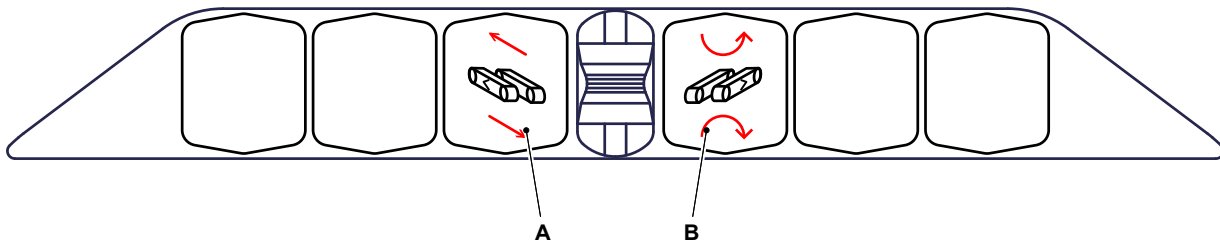

1. Operate lever A to move the tracked carrier forwards or backwards in a straight line.
 - Release lever A to stop the tracked carrier.
2. Operate lever B to make the tracked carrier turn.
 - Release lever B to stop the tracked carrier from turning.



Note

The levers return to the center position automatically.

8.1.3 Using the controls in "Tank" mode

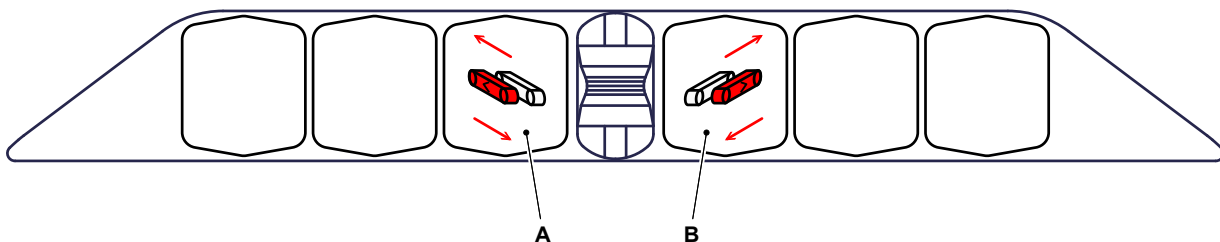

1. Operate levers A and B on the remote control simultaneously forwards or backwards to move in a straight line.
2. Operate one of the two levers to change direction.
3. Release the levers to stop the tracked carrier.
 - The levers return to the center position automatically.

8.2 Maximum slope angles when moving an unloaded tracked carrier



Caution

The values that are given in the table are for an unloaded tracked carrier only.

See the appendix for the maximum allowable angles for a tracked carrier that is carrying a load.

Direction of movement	Maximum slope angle
Forwards	45°
Backwards	45°
Sideways	40°

**Warning**

Drive slowly to prevent the tracked carrier from tilting when driving on a slope (e.g. up loading ramps onto a transport vehicle):

If you use the emergency stop while driving on a slope the tracked carrier may tilt.

8.3 Attaching the load

Attach a load with ropes or slings.

Use the holes in the side of the platform to attach the ropes or slings.

Make sure that ropes or slings are correctly rated.

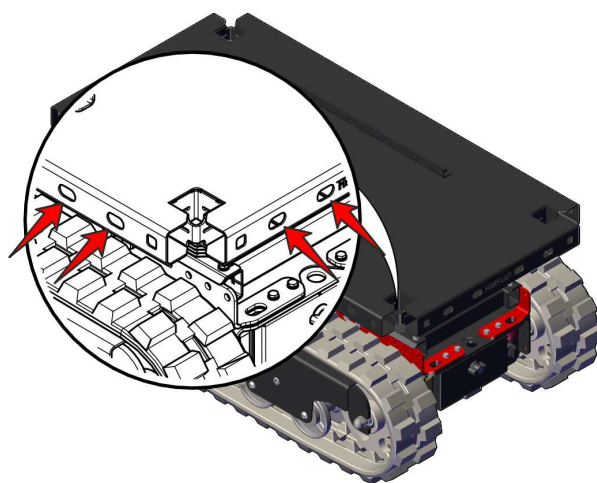

8.4 Towing a load

The tracked carrier has a maximum towing capacity of ± 1100 kgf.

However, the towing capacity is limited by:

- The surface where the tracked carrier is driving (slipping),
- The load on the tracked carrier (increase ground pressure),

Two towing eyes are located on both ends of the tracked carrier.

Attach a correctly rated sling to one (or both) towing eyes when you want to tow a load. Do not attach a load directly to the towing eyes.

Only tow a load on a flat surface.

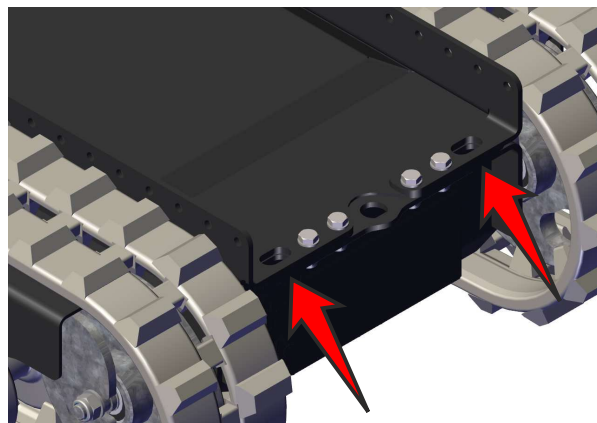
**Warning**

Make sure the load that is towed will stop without external aid. The tracked carrier does not have sufficient brakes.

**Note**

The motors are automatically adjusted so that they do not get too hot.

9.

Maintenance

9.1 Introduction

The maintenance intervals and tasks are shown in the maintenance schedule. The lubrication points and intervals are shown in the lubrication chart.

Obey these instructions and make sure that your equipment stays in good condition.

Unusual noises or vibrations can indicate a defect in the tracked carrier. Speak to your Hoeflon dealer immediately and schedule a servicing.

9.2 Maintenance work

The risk of accidents increases during maintenance, cleaning and service. Let your Hoeflon dealer do the maintenance on the tracked carrier.

The lubrication and maintenance schedules show all maintenance work and intervals. Make sure that you do the maintenance on time.

In the Netherlands, a sticker gives the date when the next inspection is necessary.

Refer to your local authorities for the rules and guidelines on the inspection of the Hoeflon TC1.



9.2.1 First use

Make sure that you do the daily inspection before using the tracked carrier for the first time .

9.2.2 Scheduled servicing

1. The first scheduled servicing is after 2 weeks or 50 hours of operation. Whichever comes first.
2. After that do the servicing of the tracked carrier every year or every 250 hours of operation. Whichever comes first.
3. Scheduled servicing and inspections must be done by your Hoeflon dealer.

9.3 Safety during maintenance

Obey the maintenance safety precautions when you do maintenance on the tracked carrier.

If you do not obey these precautions you can damage the equipment or hurt yourself or someone else.

Obey all applicable legal requirements before starting maintenance work, in particular the requirements for occupational safety and accident prevention.

Your safety and the safety of others, is most important during the maintenance of equipment.

If you do not obey the safety rules in this chapter you can damage the machine, hurt or kill someone.

- When you do maintenance work on the tracked carrier make sure that:
 - the tracked carrier is stopped.
 - the key is removed from the switch.
- Do not smoke during maintenance work.
- Do not wear rings, watches and jewelery while doing maintenance work.
- Tie back long hair so that it cannot get caught in equipment.
- Do not wear loose or hanging clothing.
- Stay away from hot surfaces.
- Only use approved non-flammable detergents.
- Never remove warning stickers.
- Obey all warnings and safety precautions on the machine and in the user manuals.
- Make sure that only approved personnel is near the tracked carrier during repair and maintenance work.
- Use correct PPE , protective clothing, gloves and safety glasses, when you do maintenance.



9.4 Maintenance schedule

The maintenance schedule indicates which maintenance must be done and at what interval.

9.4.1 General

Description of maintenance	Action	Interval in hours (o = manufacturer/dealer, ● = owner)							
		Daily	First 50 hours	50	100	250	500	1000	4000
Machine	Clean		●	●					
Safety devices	Inspect	●	●						
Control levers	Inspect	●	●						
Condition and presence of pictograms	Inspect	●	●			o			
Mechanical components	Inspect	●	●						

9.4.2 Crawler track undercarriage

Description of maintenance	Action	Interval in hours (o = manufacturer/dealer, ● = owner)							
		Daily	First 50 hours	50	100	250	500	1000	4000
Tension of crawler tracks	Inspect			●					
Friction disk	Replace (TBD)								
Brake spring	Replace	Every 100 000 activations							

9.4.3 Electrical system

Description of maintenance	Action	Interval in hours (o = manufacturer/dealer, ● = owner)							
		Daily	First 50 hours	50	100	250	500	1000	4000
Emergency stop and sensors	Inspect	●							
Wiring	Inspect					o			
Wiring connectors	Inspect					o			
Voltage	Inspect					o			

9.5 Every 50 hrs

9.5.1 Inspect crawler track tension

The tension of the crawler track is automatically adjusted.

Speak to your Hoeflon dealer if a track is loose.

10.

Troubleshooting

10.1 The remote control cannot connect with the tracked carrier

10.1.1 The LED does not flash

There is a problem with the RC6.

1. Make sure that all the levers are in the central position.
2. Calibrate the RC6 if all the levers are in the central position (see 5.3.3 Calibration)
3. Do an inspection of the **Connect** button (A).
4. Speak to your Hoeflon dealer if you still cannot connect.

10.1.2 The LED stops flashing and goes OFF

There is a problem with the tracked carrier. Speak to your Hoeflon dealer. Do not continue working.

10.2 The tracked carrier will not start

If the tracked carrier will not start, make sure that:

1. The battery is charged to a minimum of 30%, (see 10.3 The battery is fully drained),
2. There are no broken fuses, (see 10.5.1 Replace a broken fuse or relay),
3. The red switch (A) is ON.

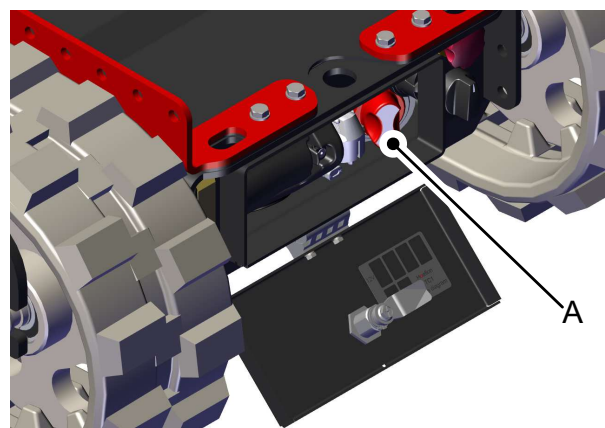

10.3 The battery is fully drained

If the battery is fully drained.

1. Connect the tracked carrier to the charger.
2. Turn the key to position **0**.
 - Charging begins after one minute.
3. Let the tracked carrier charge so that it has at least 30% charge, (see 5.4 Display).

**Note**

Use the keyswitch to start the tracked carrier. You can now monitor the State of Charge (SoC).

**Note**

It is recommended to fully charge the battery before starting work.

10.4 Error codes

**Warning**

Stop work and move the compact crane into a safe position if an error appears on the display.

Talk to your Hoeflon dealer .

**Note**

If a warning appears on the display then you must correct the defect before you can continue (see 5. Remote control).

10.5 Fuses and relays

**Note**

Always find the cause of the broken fuse first.

Repair or replace the broken part before you change the fuse.

**Warning**

Always replace a fuse with a fuse of the same rating.

10.5.1 Replace a broken fuse or relay

1. Stop the tracked carrier and remove the key.
2. Make sure that the tracked carrier is not connected to the charger.
3. Open the hatch at the front of the tracked carrier.
4. Turn the red switch (A) 90° counterclockwise.

The battery is now disconnected.

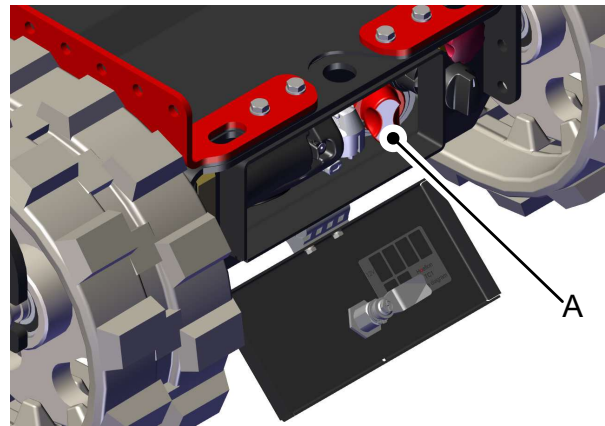

5. Remove the cover of the fuse box.
 - B. Fuse box - 12V
 - C. Fuse box - 48V
6. Replace the broken fuse or relay.

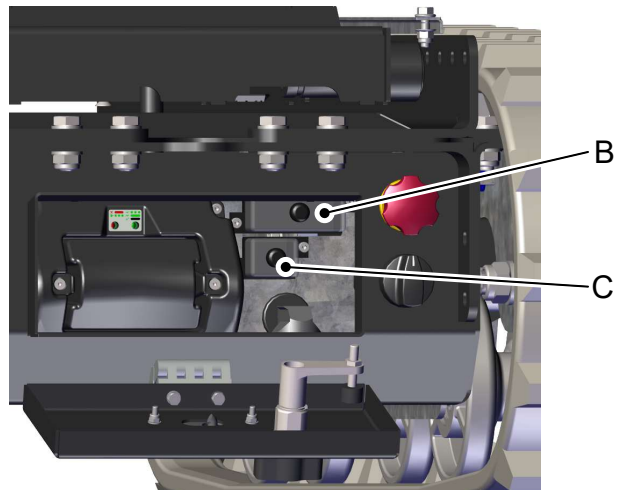

Note

Replace the fuse with a fuse of the same value.

7. Close the cover of the fuse box.
8. Turn the red switch (A) 90° clockwise to reconnect the battery.
9. Close the compartment cover.

10.5.2 Fuses

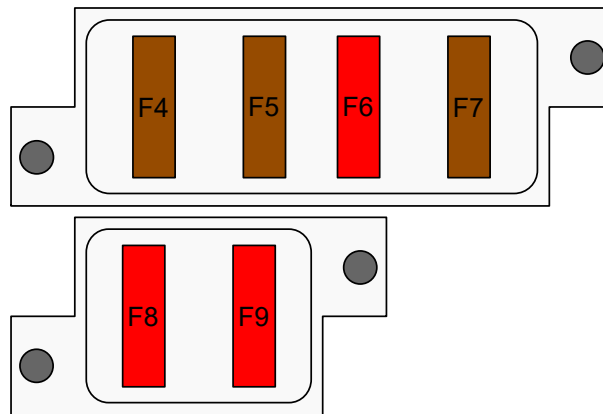

12 Volt circuit

Fuze	Amperage	Protective function
F4	5A	Battery charger of the remote control
F5	5A	Gateway 1, receiver (Remote control)
F6	10A	12Volt power to auxilliary socket
F7	5A	Lights

48 Volt circuit

Fuze	Amperage	Protective function
F8	10A	Power supply to the DC-DC converter
F9	10A	Power supply from the keyswitch to the motorcontroller

11.

Transport and storage

11.1 Transporting a tracked carrier

11.1.1 Put the tracked carrier on the transport vehicle



Caution

Make sure that the transport vehicle:

- is rated to transport the full weight of the tracked carrier (see 1.4 Type plate).
- is large enough to contain the tracked carrier (see 3.1 Dimensions).

Use loading ramps to move the tracked carrier onto the transport vehicle.

Make sure that the loading ramps:

- can carry the full weight of the tracked carrier (see 3.3.1 Basic data).
- are long enough so that the angle with the horizontal is less than the maximum permitted slope (see 3.3.2 Driving conditions).



Caution

Use slow speed when driving up a ramp or slope.



Note

Use an assistant when you move a tracked carrier up a ramp.

11.1.2 Securing the tracked carrier for transport



Note

Do not overload the brackets. This will damage the tracked carrier.

Point	Maximum load on attachment point
Lashing points on undercarriage	500 kg per eye

Put the crawler tracks of the tracked carrier directly on the deck of the transport vehicle.

Secure the tracked carrier by attaching lashing straps to holes on the side of the platform or on the front or back of the tracked carrier.

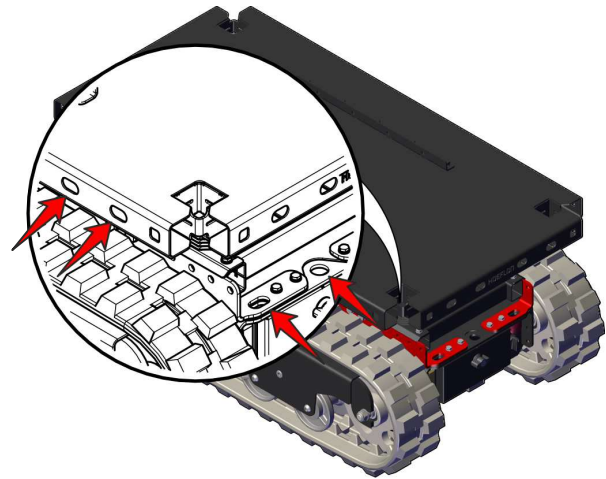

11.2 Lifting the tracked carrier

Each corner of the platform has a lifting bracket.



Note

Use a spreader bar when you lift the tracked carrier. Attach two slings to both ends of the spreader bar.

Make sure that the slings are correctly rated.

Attach a sling to the bracket on each corner of the tracked carrier.

Make sure that the tracked carrier hangs horizontally.

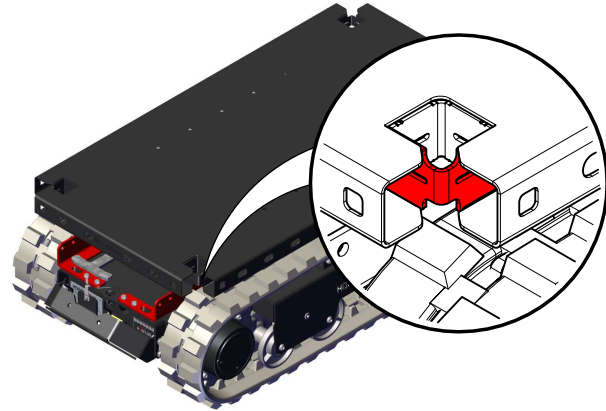

11.3 Putting the tracked carrier in storage

1. Fully clean the tracked carrier.
2. Repair all damaged paintwork.
3. Apply a thin layer of grease to the parts that may rust.

4. Keep the tracked carrier in a dry and cool area with good airflow.
5. Keep the battery charger connected to the grid.
 - The batteries remain charged.
 - The batteries will not be damaged if they are left on the charger for a long time.
6. Make sure that only approved persons are permitted to enter the storage area.
7. Make sure that the tracked carrier cannot be started by unauthorized people.
8. Cover the tracked carrier with a tarpaulin.
 - Keep a section away from the ground for ventilation.

11.3.1 Putting the tracked carrier in storage without a charging facility

If the tracked carrier is put in storage without a charging facility nearby then you must inspect the battery voltage weekly.

**Note**

Make sure that the SOC is above 30%.

Charge the battery if the SOC is below 30% .

**Note**

If it is not possible to do an inspection of the battery every week then you **MUST** disconnect the battery.

1. Stop the tracked carrier and remove the key.
2. Make sure that the tracked carrier is not connected to the charger.
3. Open the hatch at the front of the tracked carrier.
4. Turn the red switch (A) 90° counterclockwise.

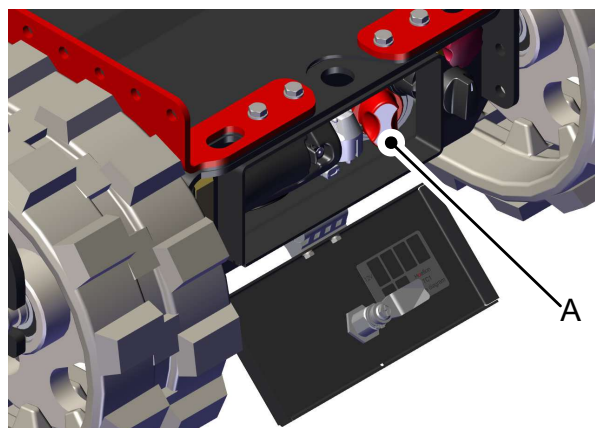

The battery is now disconnected.

Fully charge the battery after a long period of storage. This also resets and calibrates the SOC.

12.

Disposal

12.1 Dispose of the tracked carrier

Return the tracked carrier to your Hoeflon dealer at the end of its life.

12.2 Waste disposal



Note

Refer to local regulations when you discard waste material.

Incorrect disposal of waste is harmful to the environment.

Environmentally harmful waste includes but is not limited to:

- batteries,
- greases.

Appendix

13.1 Maximum slope angles



Note

Make sure that the COG of the load is within 100 mm of the center of the TC1.



Note

These tables are only valid on stable and hard surfaces.



Caution

Use LOW gear when moving up or down a slope, (see 5.2 Buttons).

13.1.1 To the side

Load COG height (mm)

	0	50	100	150	200	250	300	350	400	450	500	550	600	650	700	750	800	850	900	950	1000	
0	39	39	39	39	39	39	39	39	39	39	39	39	39	39	39	39	39	39	39	39	39	39
50	36	35	35	34	33	33	32	32	31	30	30	29	29	28	28	27	27	27	26	26	25	25
100	34	33	32	31	30	29	28	27	26	25	25	24	23	22	22	21	20	20	19	19	18	18
150	32	31	29	28	27	26	25	24	23	22	21	20	19	18	18	17	16	15	15	14	14	14
200	31	29	28	26	25	24	22	21	20	19	18	17	16	15	15	14	13	12	12	11	11	11
250	30	28	26	25	23	22	20	19	18	17	16	15	14	13	13	12	11	10	10	9	8	8
300	29	27	25	23	22	20	19	18	17	16	14	13	12	11	10	9	9	8	8	7	7	7
350	28	26	24	22	21	19	18	17	15	14	13	12	11	10	10	9	8	7	7	6	5	5
400	27	25	23	21	20	18	17	16	14	13	12	11	10	9	9	8	7	6	6	5	4	4
450	27	24	22	21	19	17	16	15	14	12	11	10	9	8	8	7	6	5	5	4	3	3
500	26	24	22	20	18	17	15	14	13	12	11	10	9	8	7	6	5	5	4	3	3	3
550	26	23	21	19	18	16	15	13	12	11	10	9	8	7	6	5	5	4	3	3	2	2
600	25	23	21	19	17	16	14	13	12	10	9	8	7	7	6	5	4	3	3	2	2	2
650	25	23	20	19	17	15	14	12	11	10	9	8	7	6	5	4	4	3	2	2	1	1
700	25	22	20	18	16	15	13	12	11	10	8	7	6	5	4	3	3	2	2	1	1	1
750	24	22	20	18	16	14	13	12	10	9	8	7	6	5	4	4	3	2	2	1	0	0
800	24	22	19	18	16	14	13	11	10	9	8	7	6	5	4	3	3	2	1	1	0	0
850	24	21	19	17	15	14	12	11	10	9	7	6	5	5	4	3	2	2	1	0	0	0
900	24	21	19	17	15	14	12	11	9	8	7	6	5	4	4	3	2	1	1	0	0	0
950	24	21	19	17	15	13	12	10	9	8	7	6	5	4	3	2	2	1	0	0	0	0
1000	23	21	19	17	15	13	12	10	9	8	7	6	5	4	3	2	2	1	0	0	0	0

13.1.2 Forward and backward

		Load COG height (mm)																				
		0	50	100	150	200	250	300	350	400	450	500	550	600	650	700	750	800	850	900	950	1000
Load (KG)	0	47	47	47	47	47	47	47	47	47	47	47	47	47	47	47	47	47	47	47	47	
	50	45	44	44	43	43	42	42	41	41	40	40	39	38	38	38	37	37	36	36	35	35
	100	43	42	41	40	39	38	37	36	36	35	34	33	32	32	31	30	29	29	28	27	27
	150	41	40	39	38	36	35	34	33	32	31	30	29	28	27	26	25	25	24	23	22	21
	200	40	39	37	36	34	33	32	30	29	28	27	26	25	24	23	22	21	20	19	19	18
	250	39	37	36	34	33	31	30	28	27	26	25	23	22	21	20	19	18	17	17	16	15
	300	38	36	34	33	31	30	28	27	25	24	23	21	20	19	18	17	16	15	15	14	13
	350	37	35	33	32	30	28	27	25	24	22	21	20	19	18	17	16	15	14	13	12	11
	400	37	35	33	31	29	27	26	24	23	21	20	19	17	16	15	14	13	12	11	11	10
	450	36	34	32	30	28	26	25	23	21	20	19	18	16	15	14	13	12	11	10	9	9
	500	36	33	31	29	27	25	24	22	21	19	18	17	15	14	13	12	11	10	9	8	8
	550	35	33	31	29	27	25	23	21	20	18	17	16	15	13	12	11	10	9	8	8	7
	600	35	32	30	28	26	24	22	21	19	18	16	15	14	13	12	11	10	9	8	7	6
	650	34	32	30	27	25	24	22	20	19	17	16	14	13	12	11	10	9	8	7	6	5
	700	34	32	29	27	25	23	21	20	18	17	15	14	13	11	10	9	8	7	7	6	5
	750	34	31	29	27	25	23	21	19	18	16	15	13	12	11	10	9	8	7	6	5	4
	800	34	31	29	26	24	22	20	19	17	16	14	13	12	11	9	8	7	7	6	5	4
	850	33	31	28	26	24	22	20	18	17	15	14	13	11	10	9	8	7	6	5	4	4
	900	33	30	28	26	23	21	20	18	16	15	13	12	11	10	9	8	7	6	5	4	3
	950	33	30	28	25	23	21	19	18	16	15	13	12	11	9	8	7	6	5	5	4	3
1000	33	30	27	25	23	21	19	17	16	14	13	12	10	9	8	7	6	5	4	3	3	